

# Data Sheet



Article number: 2307083294

Description: E+G Direct drive position indikator  
DD52R-FN-0010.0-S-C2 (Orange)

## Measures

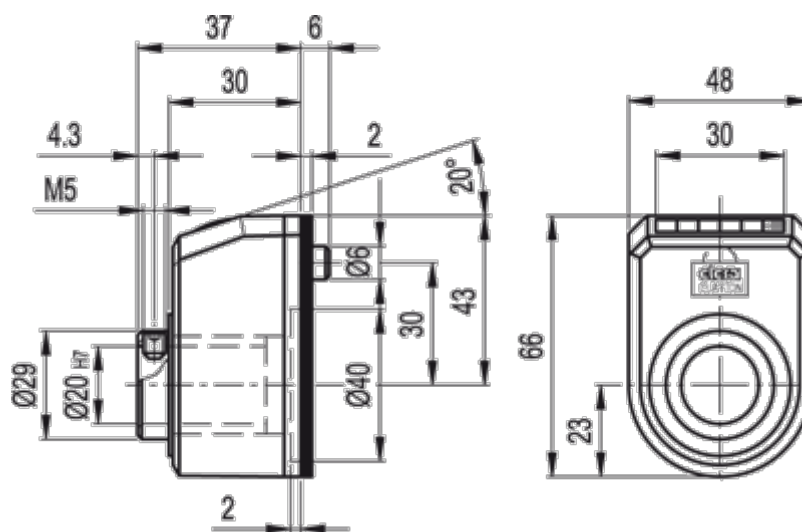

Max rpm = 250